

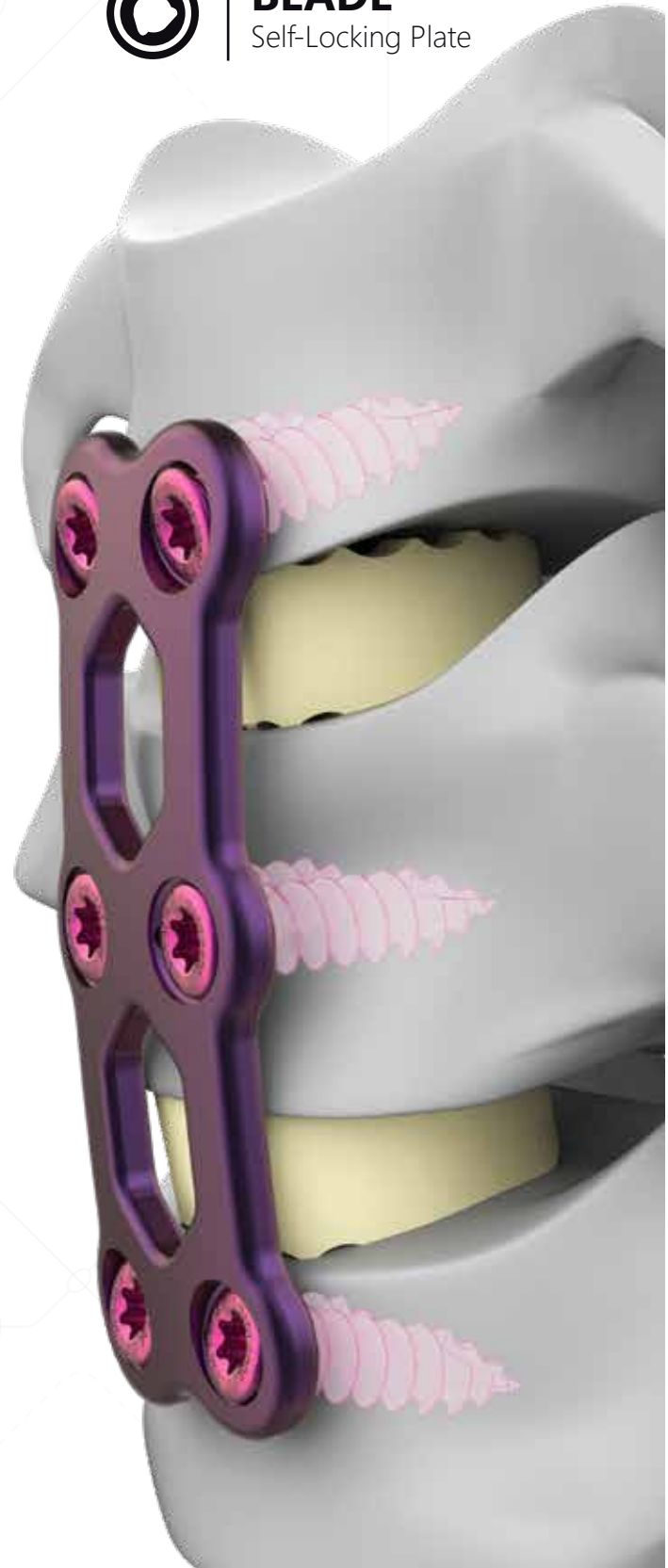

BLADE[®]
Self-Locking Plate



STRUXXURE[®]
Hybrid-Locking Plate



TECHNOLOGY

Patented Hurricane Lock

WEDGE-IN

Tapered screw wedges into plate

SCREW FIXATION

Hurricane lock fixates screw preventing screw backout

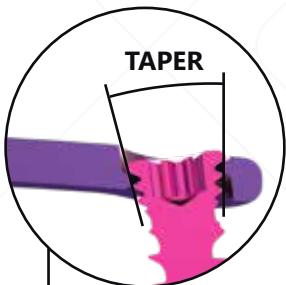

Patent Protected
US #8,834,536
US #9,149,311

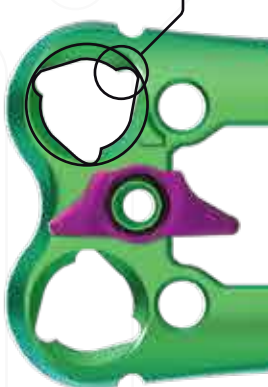

ULTRA THIN 1.95MM PLATES



INSERTERS

Tapered Connection

Threaded Connection



COMPATIBLE SYSTEMS

NEXXT MATRIX[®]
3D Printed Titanium
Cervical Interbody



FOOTPRINTS:
12x14, 14x16, 16x18mm
HEIGHTS:
5-10 // 11-18mm
LORDOSIS:
6°, 0°

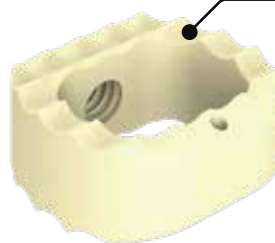

HONOUR[®]
PEEK Cervical Interbody

FOOTPRINTS:
12x12, 12x14, 14x16, 16x18mm
HEIGHTS:
5-10 // 11-18mm
LORDOSIS:
10°, 6°, 0°

standard // optional

TD ELITE

Trial Drill Guide System

All in one: interbody trial, drill guide, and plate length determination.

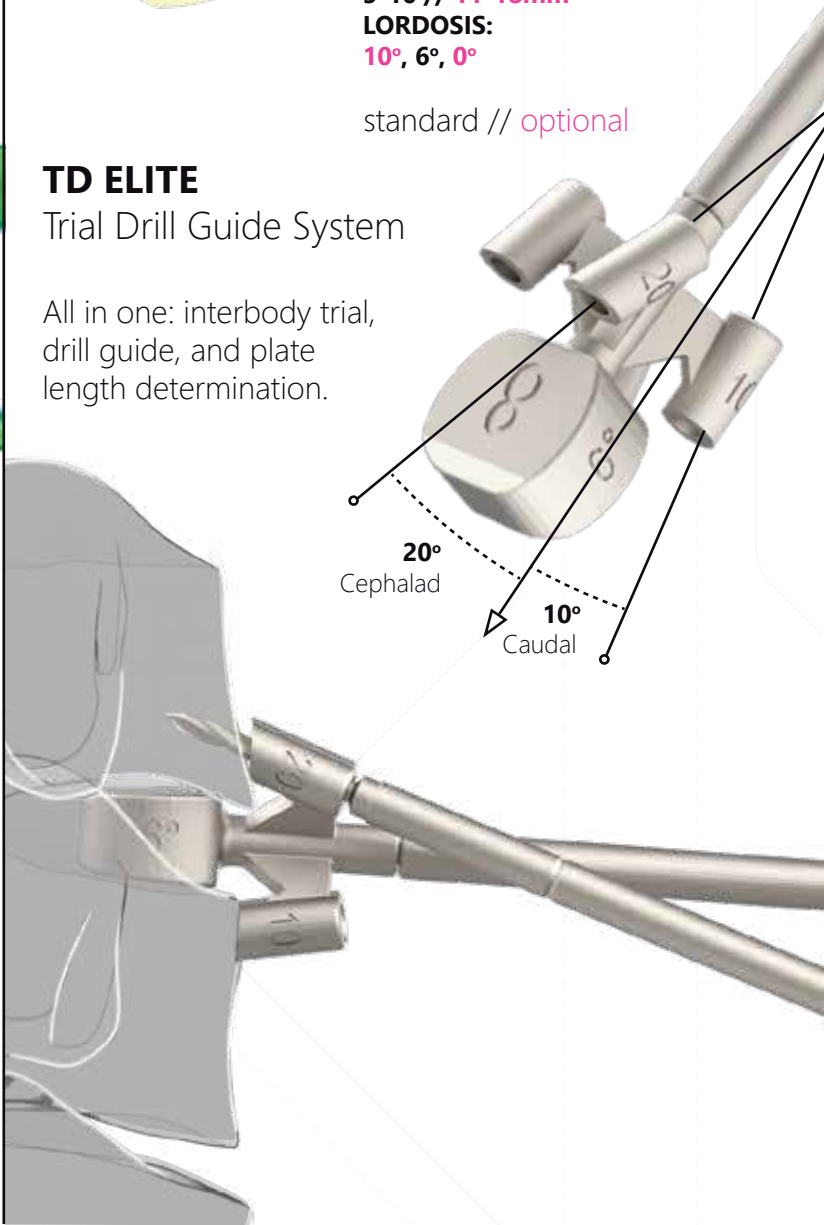



STRUXXURE®
Hybrid-Locking Plate

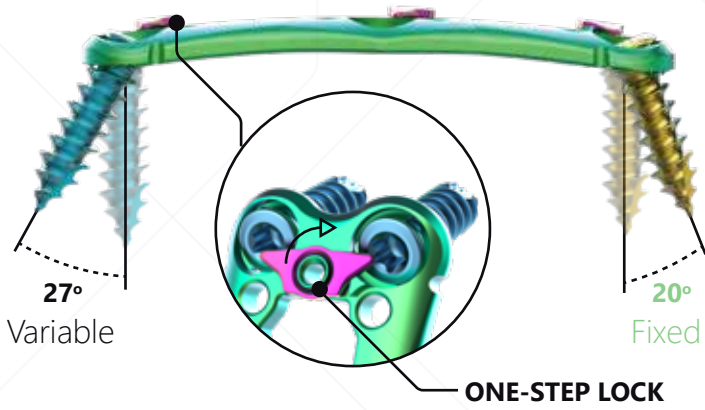

5 PLATE LEVEL OPTIONS
standard // optional

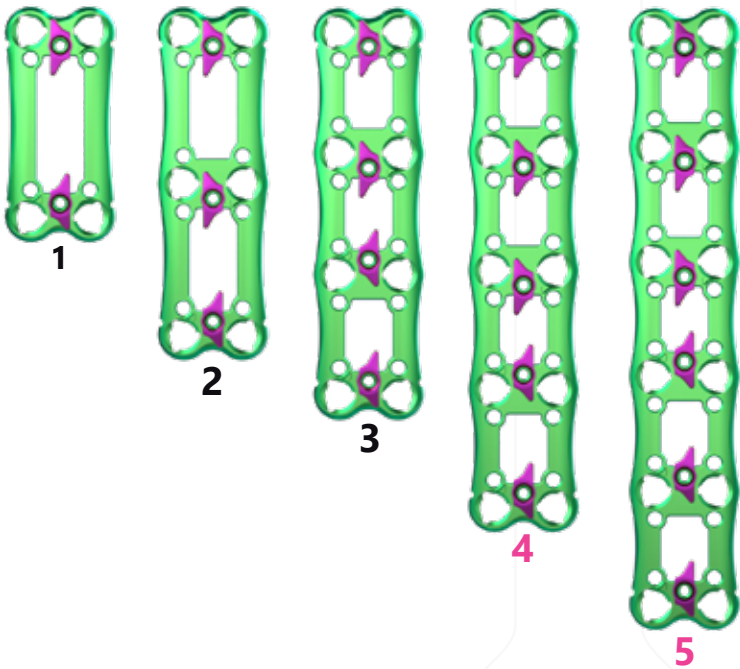

SCREW OPTIONS
variable // fixed

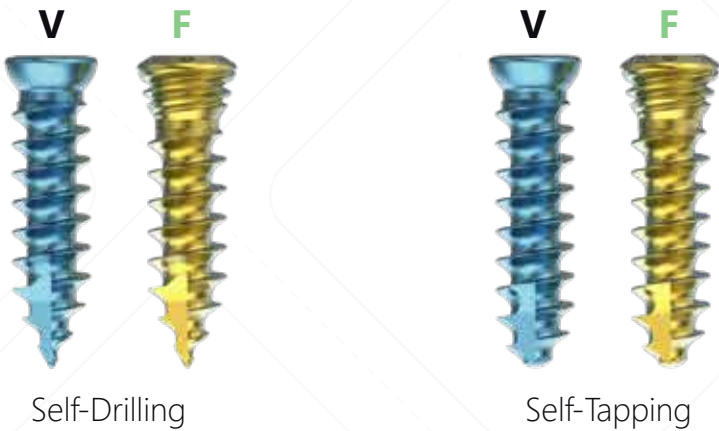

BLADE®
Self-Locking Plate

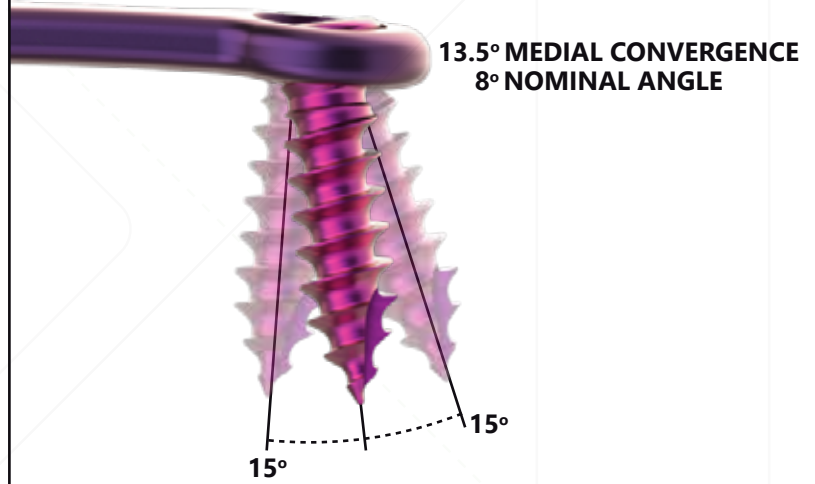

5 PLATE LEVEL OPTIONS
standard // optional

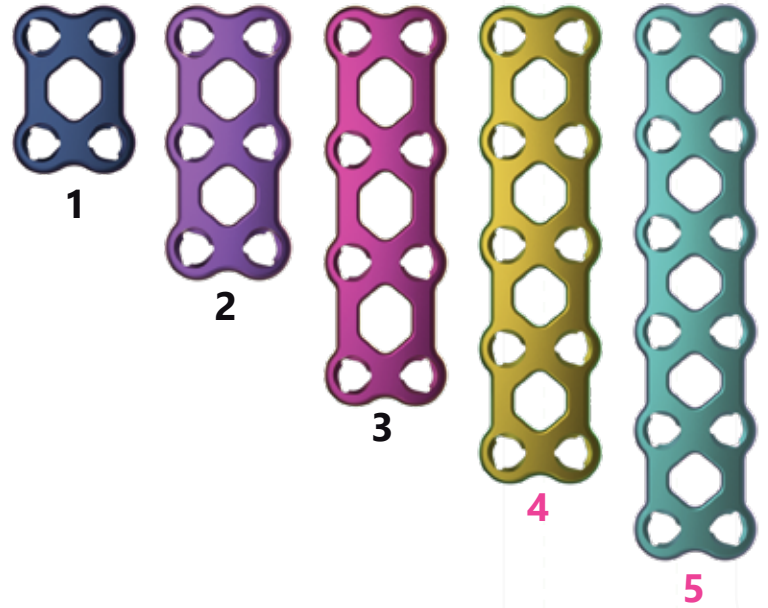

SCREW OPTIONS
fixed

